

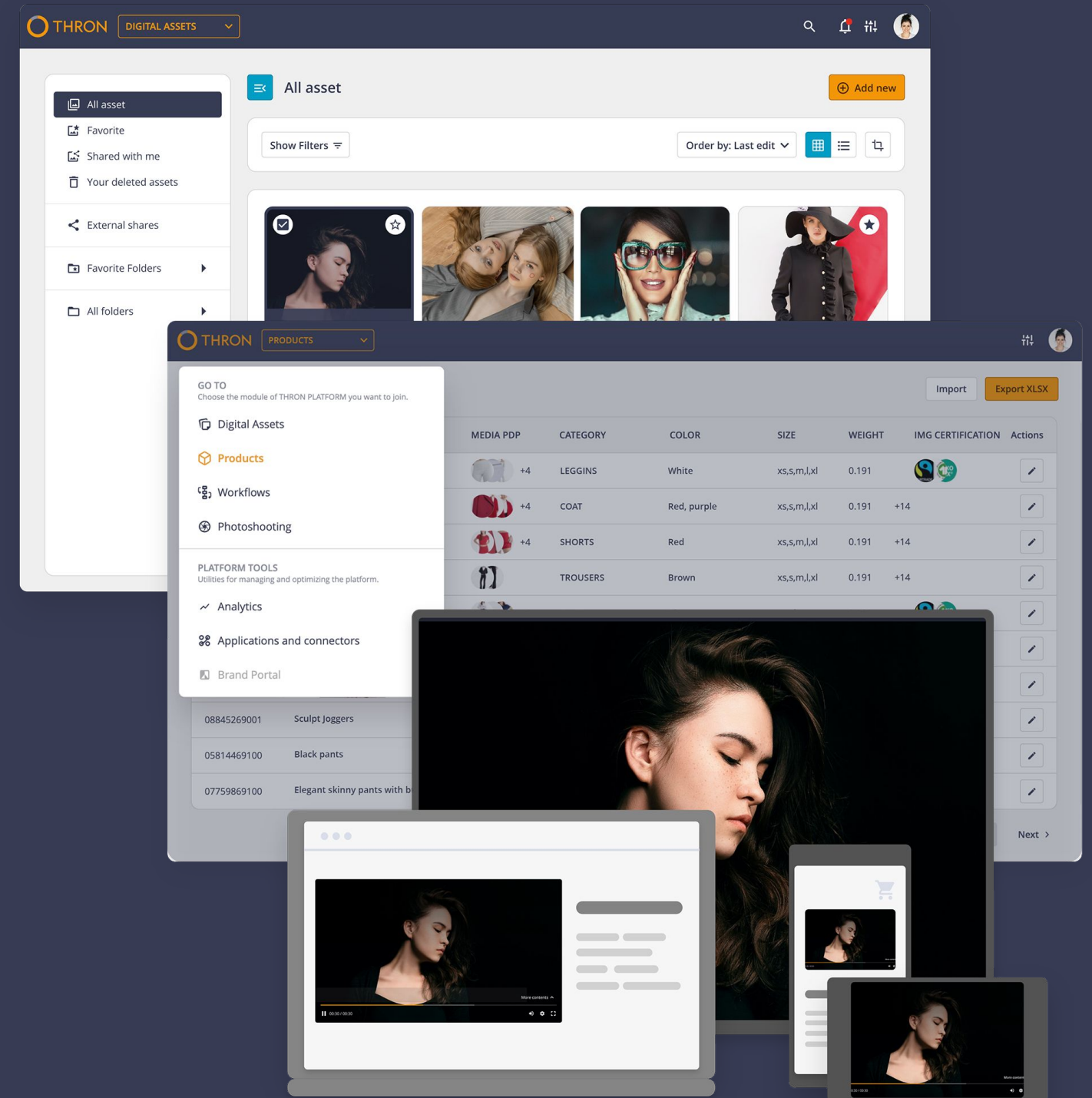

AI-SaaS for Product & Asset Management

Too Many Tools. Too Much Wasted Time.
THRON Fixes It.



ABOUT US

The Italian AI-SaaS that eliminates the chaos of managing content and product data - so you can **SAVE TIME**.

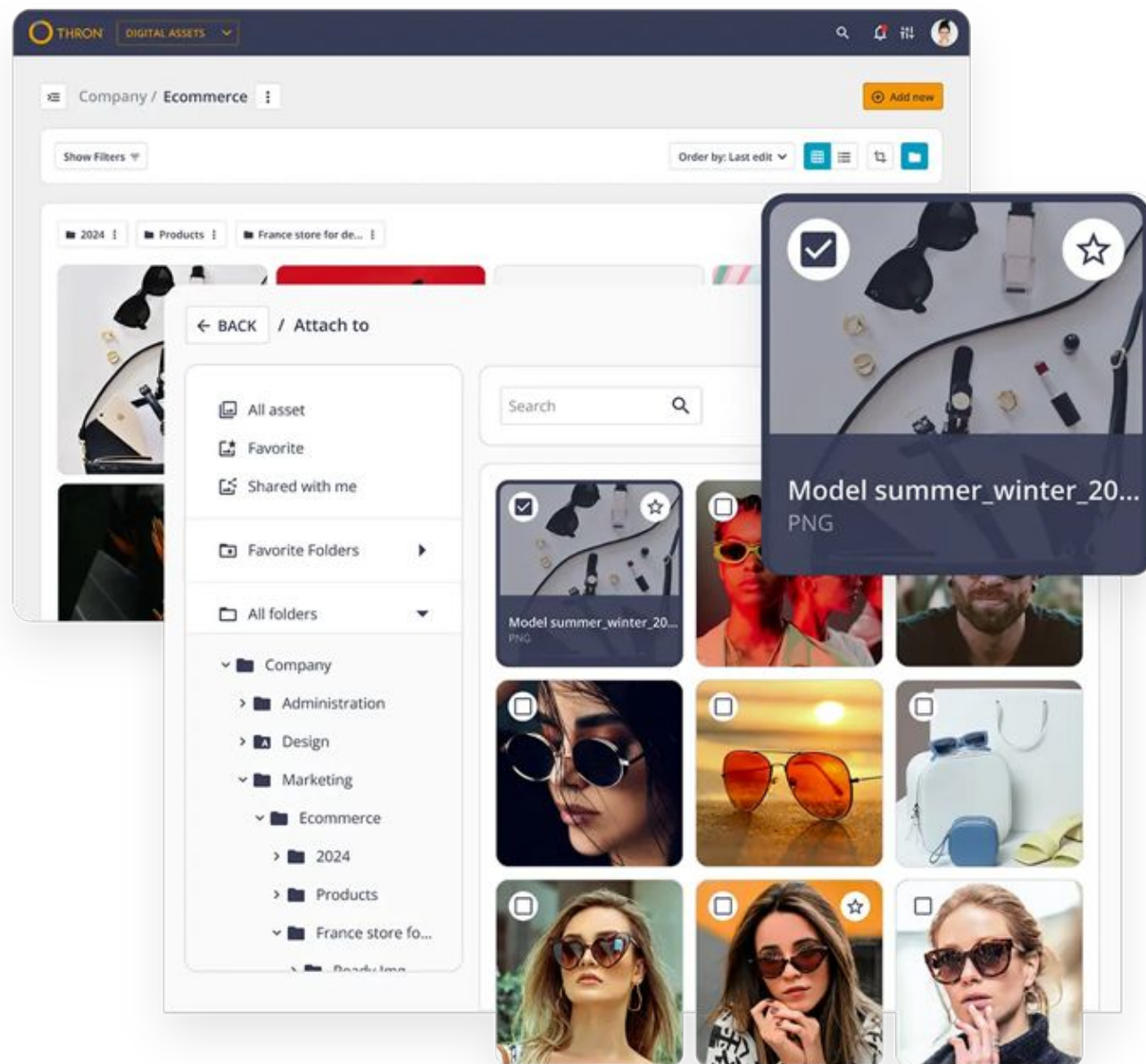

ONE UNIFIED PLATFORM FOR DAM, PIM, AND MEDIA DELIVERY.

1. **One platform instead of many.** No more DAM, PIM, and media delivery stitched together.
2. **Faster, smarter, cost-effective.** AI-driven automation for instant efficiency.
3. **Effortless workflows.** Seamless collaboration, real-time distribution - no bottlenecks.

PROBLEM

Businesses are wasting time and resources. It's time for a smarter approach.

- **TOO MANY DISCONNECTED TOOLS**

DAM, PIM, and media delivery systems are fragmented.

- **SLOW WORKFLOWS**

Endless approvals, manual processes, and scattered content across platforms.

- **HIGH COSTS**

Licensing multiple tools, IT complexity, and inefficiencies drain budgets.



SOLUTION

THRON Saves Time, so you can focus on Growth.



UNIFIED WORKFLOW

One unified flow
(**Production-Readiness-Distribution**)
AI-assisted automation
significantly boosts
productivity.

ONEinstant



CENTRALIZED DISTRIBUTION

Intelligent asset
distribution ensures instant
updates across all channels
(owned and syndicated).

ONEtime



COST EFFECTIVE

One Single Integration:
a unified system with
modern APIs and
connectors, making it
highly cost-effective.

ONEfee

OUR COMPETITIVE EDGE

One, Unified, Platform

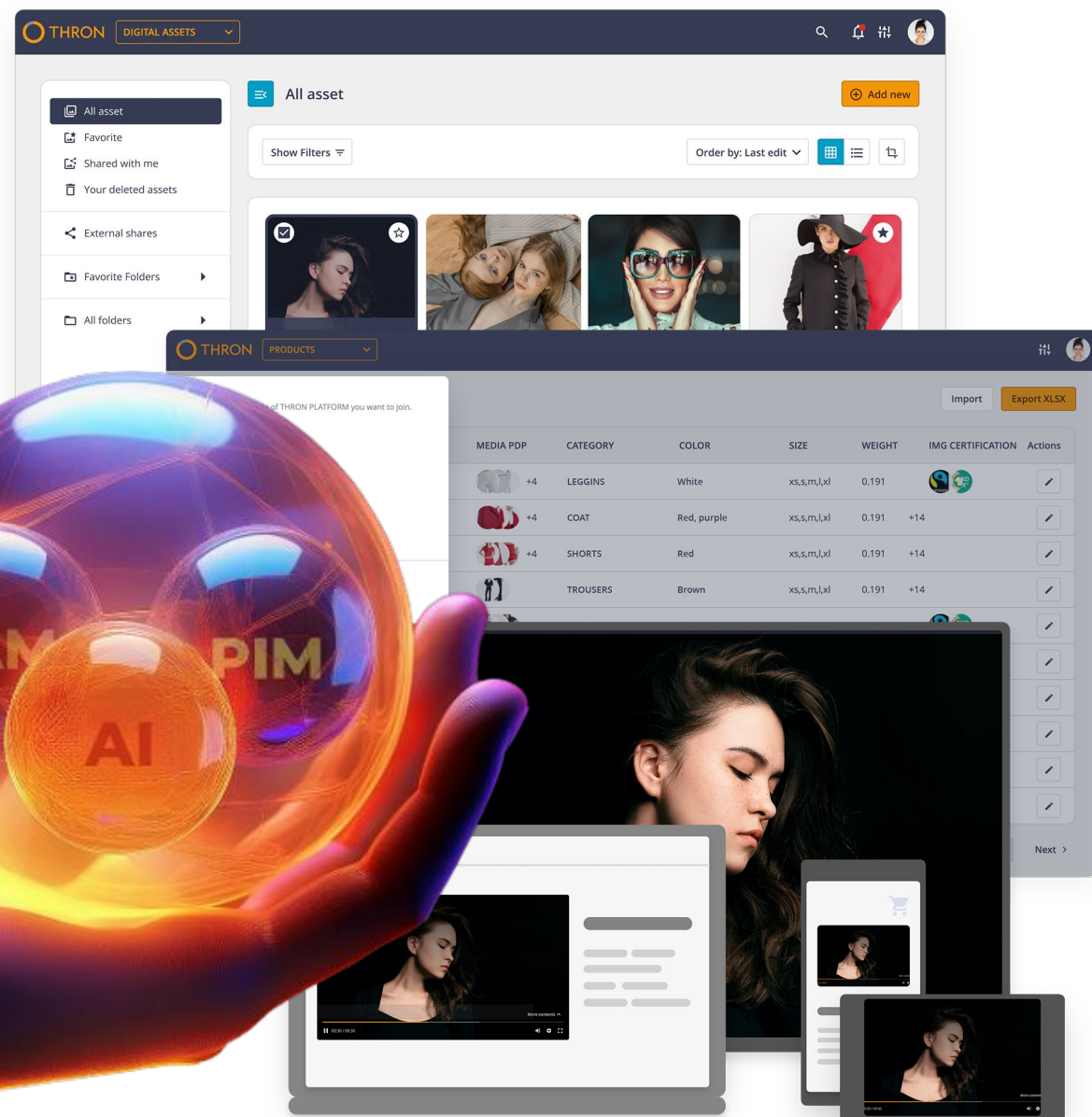

- 1. NATIVELY UNIFIED, RADICALLY EFFICIENT**
 Unlike others, THRON isn't a patched DAM + PIM. **One core, one API = unmatched speed & cost savings.**
- 2. CUSTOMER-DRIVEN INNOVATION**
 We evolve with industries, anticipating challenges to **deliver cutting-edge efficiency.**

ENTERPRISE DIGITAL ECOSYSTEM

before THRON Platform: data fragmentation and expensive integrations

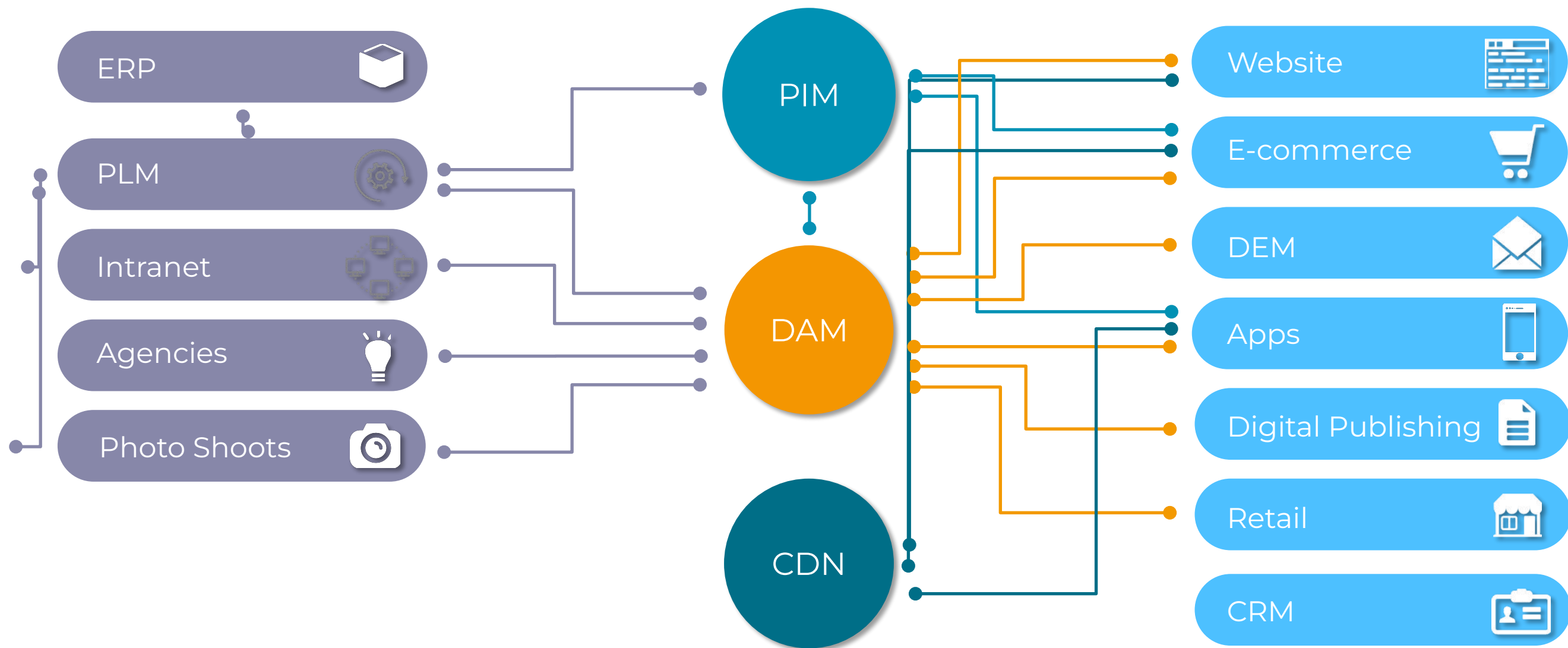

 Copy of digital content and data

ENTERPRISE DIGITAL ECOSYSTEM

with THRON Platform: simple, fast and smart

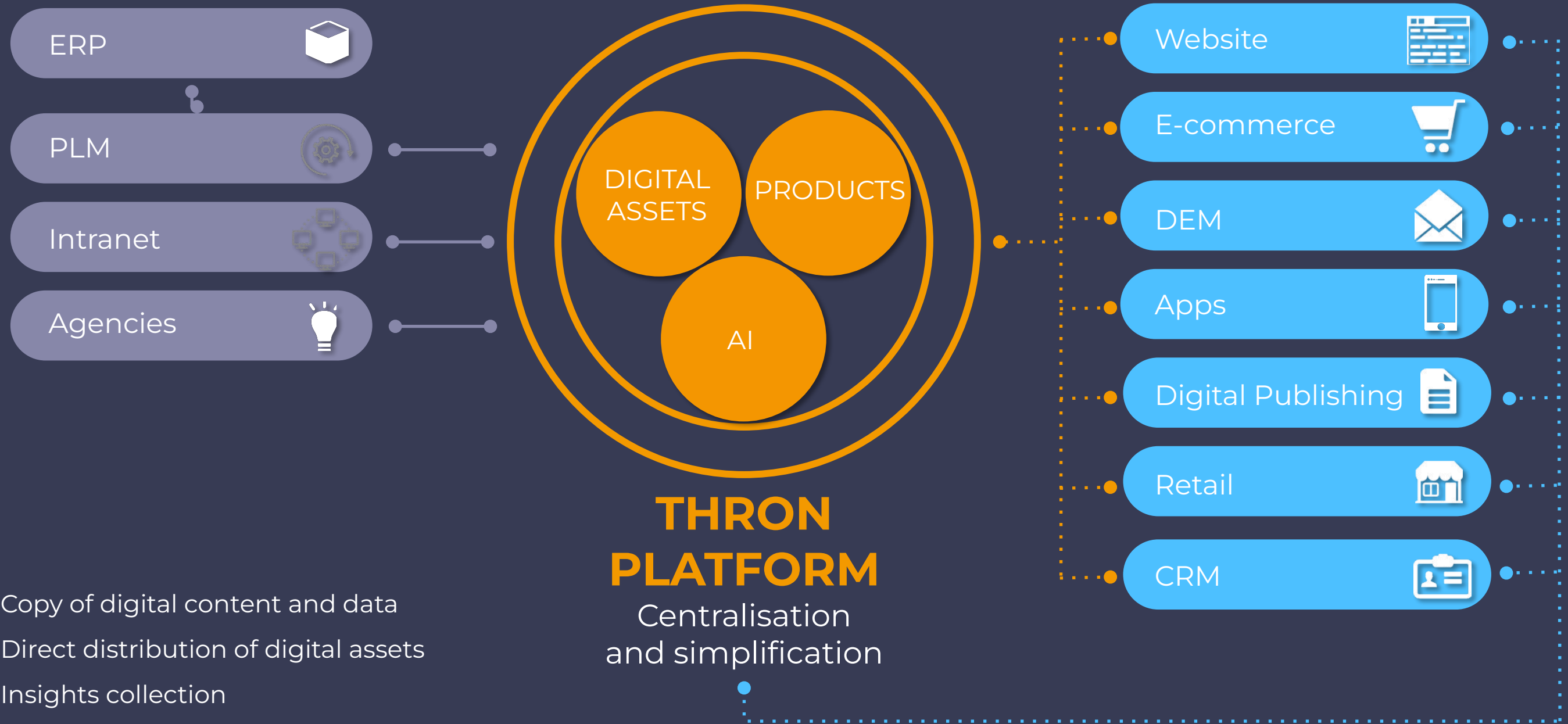

THRON IN ACTION

Less time managing content. More time growing your business.

PLATFORM MODULES



Digital Asset Library

Your single source of truth for all digital assets - AI-tagged, organized, and instantly accessible.



Product Sheet Library

Automate, enrich, and distribute product information at scale - faster, smarter, always up to date.



AI & AUTOMATION

Eliminate manual work with AI-driven tagging, content generation, and workflow automation - effortless and instant.



Delivery & Syndication

Deliver optimized content instantly across e-commerce, B2B platforms, marketplaces, and beyond.



B2B and Brand Portal

A seamless, self-service hub for partners, resellers, and teams - always aligned, always accessible.



Dynamic Print Publishing

Generate, update, and publish catalogs and brochures in real time - directly from your product data.

ARCH&TECH

Pure SaaS. Extreme Performance. Absolute Reliability.

At THRON we use **container technology and micro-services in 'autoscaling'**.

- ✓ Our distributed architecture allocates or shuts down parts of infrastructure as needed.
- ✓ Automated recovery procedures ensures faster resolution times than manual intervention.



POSITIONING&KPI

THRON Economic Impacts

Source: *The Total Economic Impact of THRON™*, conducted by Forrester Consulting, analysing a sample of THRON's customers.

-55%

IT COSTS

including software
and system integration

- 3

MONTHS

Saved per user in managing
assets and product data



+70%

PERFORMANCE

faster website performance
thanks to AI optimizations

“Adopting an asset lifecycle management approach has allowed us to accelerate time-to-market and enhance content governance.”

Chief Innovation Officer – Dolce&Gabbana

THE FUTURE OF THRON

We don't follow trends. We create them.

**From
Automation to
Autonomy**

AI work for you, users
simply validate.

Less effort, more
efficiency.

**End-to-End
Process
Fluidity**

Continuous evolution to
make workflows faster,
smarter, and fully
automated.

**Expanding
Integration &
Partnership**

Strengthening
connections to
automate data and
content exchange.

AI-Driven. Effortless. Seamlessly Connected.

FROM FASHION TO MANUFACTURING, THRON IS REDEFINING EFFICIENCY.

	FASHION	AQUAZZURA	DOLCE & GABBANA	 ELISABETTA FRANCHI	GEOX	 LA MARTINA	MONCLER	TWINSET MILANO	VALENTINO	WOOLRICH
	BEAUTY	 ALAMA PROFESSIONAL	GSK	 BioVire HEALTH AND BEAUTY	Echosline theveganway	Fanola CREATIVITY TO SHARE	goovi good. easy. natural.	 PETENON COSMETICS PROFESSIONAL HAIR & SKIN CARE	SODALIS GROUP	Tesori d'Oriente
	RETAIL & GDO	 DAL 1877 Barilla	bennet	 EATALY alti cibi	elior	GRUPPO COIN	 LA LINEA VERDE Insalate pronte Dimmi!	Lagardere	 Q	 Giuseppe Rana RANA
	MANUFACTURING	 ARISTON THERMO GROUP	CAME	 fitt TECHNOLOGY FLOW	GIVI	 MITSUBISHI ELECTRI	KitchenAid	 PLATUM Shaping urban e-mobility	 SG Stevanato Group	 Whirlpool CORPORATION
	FURNITURE	arper	 atlas concorde	LAGO	LAMINAM SUPERIOR NATURAL SURFACES	 LUXY	MARGRAF	 PERFORMANCE LIGHTING	SCAVOLINI	 snaidero CUCINE PER LA VITA
	AUTOMOTIVE	 Ferrari	IVECO GROUP	 LAMBORGHINI	 SPORT & GOODS	 CHERVO	 DAINESE	Selle Royal Group	 Wilier TRIESTINA	
	OTHER	 AC	 adnkronos	 MONDADORI	 1915 FERRETTI GROUP PASSION. INNOVATION. EXCELLENCE.	 FAAC Simply automatic.	 Kress	 MSC	 TRENORD	

ABOUT US

THRON: Instant Control of Digital Know-How

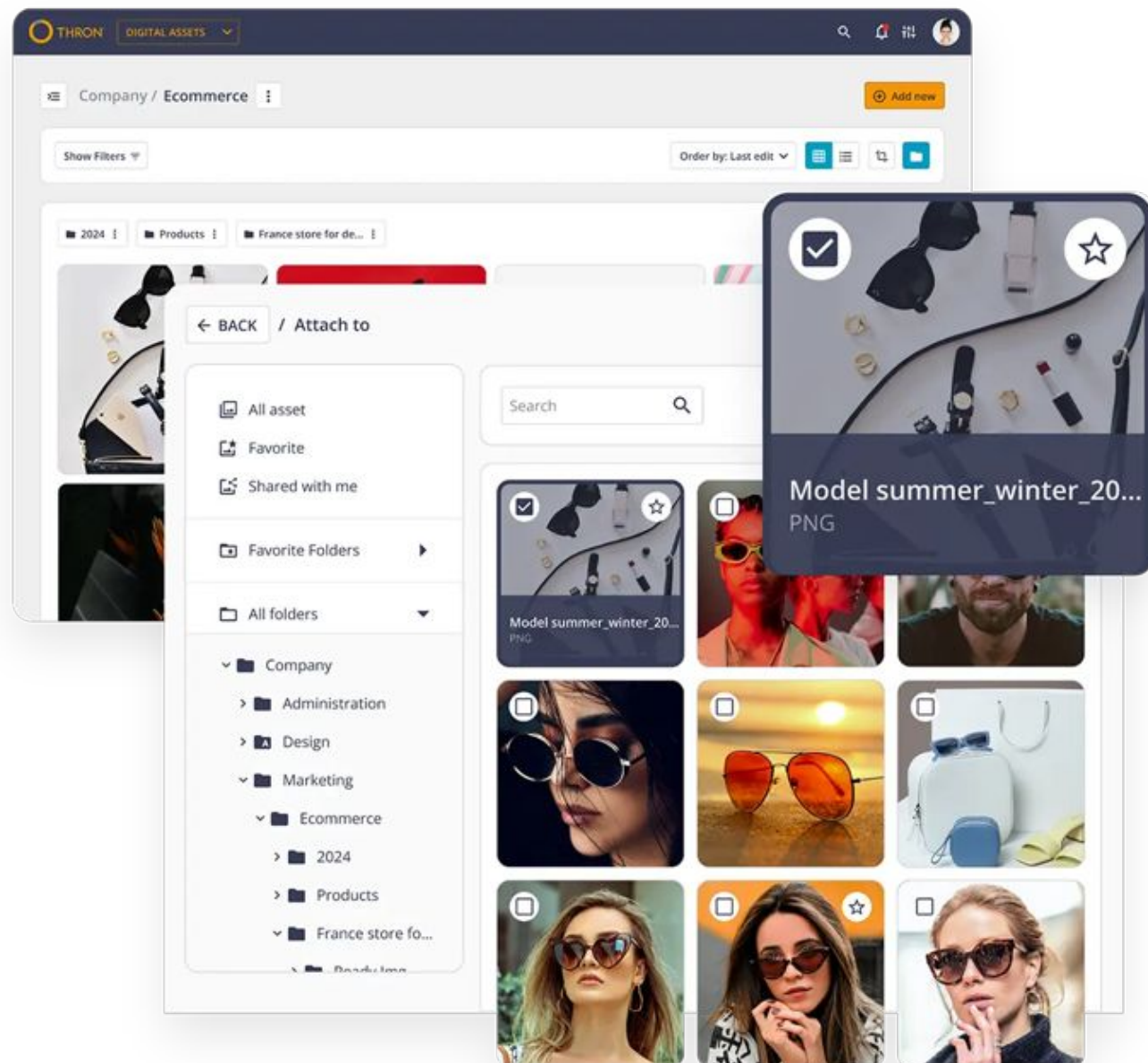

OUR VISION

Our vision is to empower companies with instant control over their digital know-how.

HOW?

Through **agile**, **AI-assisted**, and **cost-effective solutions** that streamline processes and drive efficiency.

NUMBERS

THRON in numbers

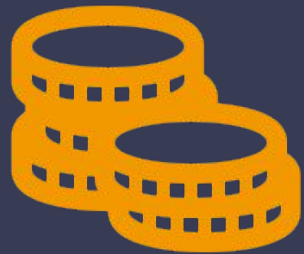

7.000K

2024
global turnover



55

employees
in 2024



+200

global
customers



THRON

SAVE TIME